

تم تحميل وعرض المادة من :



موقع واجباتك

www.wajibati.net

موقع واجباتي منصة تعليمية تساهم بنشر حل المناهج الدراسية بشكل متميز لترتقي بمجال التعليم على الإنترنت ويستطيع الطلاب تصفح حلول الكتب مباشرة لجميع المراحل التعليمية المختلفة



حمل التطبيق من هنا

المادة : لغة انجليزية
الصف : _____ الابتدائي
الزمن : ساعة و نص

المملكة العربية السعودية
وزارة التعليم
إدارة تعليم
مدرسة ابتدائية

اختبار النهائي الفصل الدراسي الثالث (-الدور الأول -) للعام الدراسي 1444هـ

س	المهارة	الدرجة	بالارقام	الدرجة بالاحرف	المصححه	المراجع	المدققة
1		6					
2		4					
3		6					
4		4					
5		5					
6		5					
	المجموع	30					
	اسم الطالبة	-----			الفصل	رقم الجلوس	

Q1. General Questions:

6

Match

- | | |
|-------------------------------|----------------------------|
| 1-Where's Ali? | () They are 3 . |
| 2-How many candies are there? | () it's a wallet. |
| 3-What's this? | () She's a teacher. |
| 4-Can I use your eraser ? | () he is in the kitchen . |
| 5-Can ostriches fly? | () Here you go . |
| 6- What does she do? | () Yes, they can. |



Q2. Reading:

4

Match

1. The cat is under the cotton thread.
2. Its jaws are huge.
3. She has long black hair .
4. He is a farmer.



Q3. Vocabulary:

6

A- Match the numbers with the pictures:

1- livingroom	2- kitchen	3- a wallet	4- rainy	5- MP3player	6- cloudy
<input type="checkbox"/>	<input type="checkbox"/>	<input type="checkbox"/>	<input type="checkbox"/>	<input type="checkbox"/>	<input type="checkbox"/>

B-Circle the correct word :

Glue	pencil	tub	pilot	doctor	park
paper	pen	bed	teacher	astronaut	cgym





Q4. Orthography A-Complete the missing letter:

4

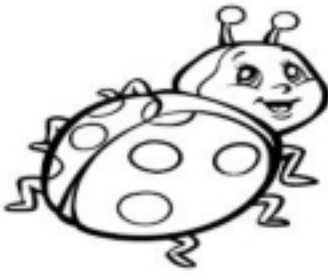

(ee _ea _ sp _ sw _ pr _ oo_ ou _ fr)

			
__ider	__esent	__ies	__an
			
h__d	sl__p	h__se	f__t

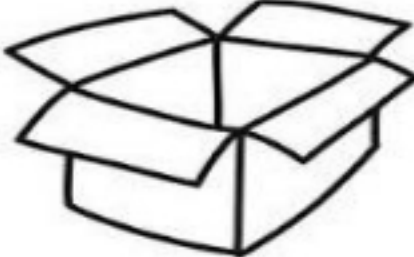
B-Choose the right spelling

	__ile				b__g		
	sn	sm	sl		o	u	a
	__ail.				b__x		
	sn	sm	sl		o	u	a

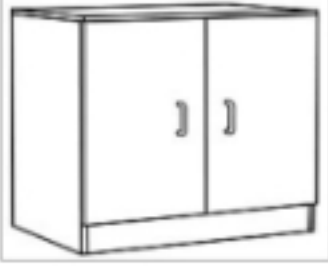
C-Unscramble the letters and write

	e a l b t		b u p c d a o r
	r a i c h		d i r e g f



Q5. Writing :

5

Do as shown between brackets:

A.(rearrange)

1- In the bathroom / He / is.

2-he/ a firefighter / Is /?

C-(Complete)> (get- eat - those - these)

1- I _____ lunch.



2-I _____ up early.



3-What are _____ ?

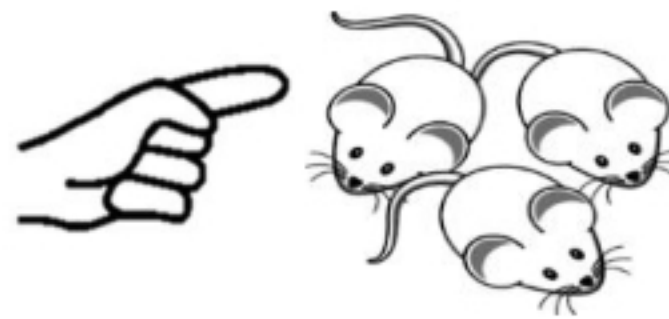

Q6. Grammar:

5

1. (She - They- I) is in the kitchen.
2. She (work - works- working) in a school.
3. They (go - goes - going) to school in the morning.
4. I go to school (in - on - at) morning.
5. (Which - Where - What) is Hashim ? He is in the bedroom.

Good Luck

المادة : لغة انجليزية
الصف : _____ الابتدائي
الزمن : ساعة و نص

المملكة العربية السعودية
وزارة التعليم
إدارة تعليم
مدرسة ابتدائية

اختبار النهائي الفصل الدراسي الثالث (-الدور الأول -) للعام الدراسي 1444هـ

س	المهارة	الدرجة	بالارقام	الدرجة بالاحرف	المصححه	المراجعه	المدققة
1		6					
2		4					
3		6					
4		4					
5		5					
6		5					
	المجموع	30					
	اسم الطالبة			-----	الفصل	رقم الجلوس	

نموذج إجابة

Q1. General Questions:

6

Match

- | | |
|-------------------------------|------------------------------|
| 1-Where's Ali? | (2) They are 3 . |
| 2-How many candies are there? | (3) it's a wallet. |
| 3-What's this? | (6) She's a teacher. |
| 4-Can I use your eraser ? | (1) he is in the kitchen . |
| 5-Can ostriches fly? | (4) Here you go . |
| 6- What does she do? | (5) Yes, they can. |



Q2. Reading:

4

Match





1. The cat is under the cotton thread.
2. Its jaws are huge.
3. She has long black hair .
4. He is a farmer.





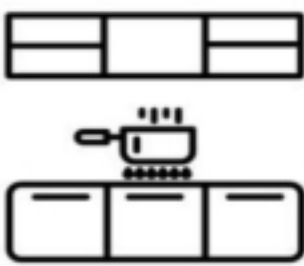

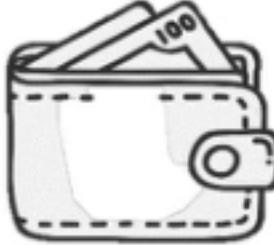

Q3. Vocabulary:

6

A- Match the numbers with the pictures:

1-	2-	3-	4-	5-	6-
livingroom	kitchen	a wallet	rainy	MP3player	cloudy
					
2	4	1	5	6	3

B-Circle the correct word :

					
Glue	<u>pencil</u>	tub	<u>pilot</u>	doctor	<u>park</u>
<u>paper</u>	pen	<u>bed</u>	teacher	<u>astronaut</u>	cgym





Q4. Orthography A-Complete the missing letter:

4



(ee _ea _ sp _ sw _ pr _ oo_ ou _ fr)

			
<u>sp</u> ider	<u>pr</u> esent	<u>fr</u> ies	<u>sw</u> an
			
<u>h</u> ead	<u>s</u> leep	<u>h</u> ouse	<u>f</u> oot

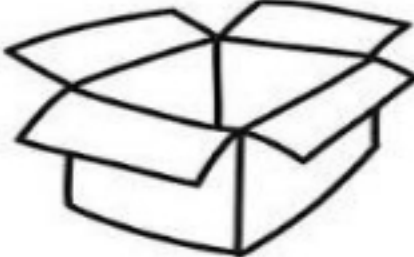
B-Choose the right spelling

	_ _ ile				b _ g		
	sn	<u>sm</u>	sl		o	<u>u</u>	a
	_ _ ail.				b _ x		
	sn	sm	sl		<u>o</u>	u	a

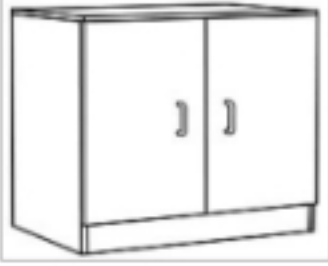
C-Unscramble the letters and write

	e a l b t		b u p c d a o r
	table		cupboard
	r a i c h		d i r e g f
	chair		fridge



Q5. Writing :

5

Do as shown between brackets:

A.(rearrange)

1- In the bathroom / He / is. He is in the bathroom.

2-he/ a firefighter / Is /? Is he a firefighter?.

C-(Complete)> (get- eat - those - these)

1- I eat lunch.



2-I get up early.



3-What are these?

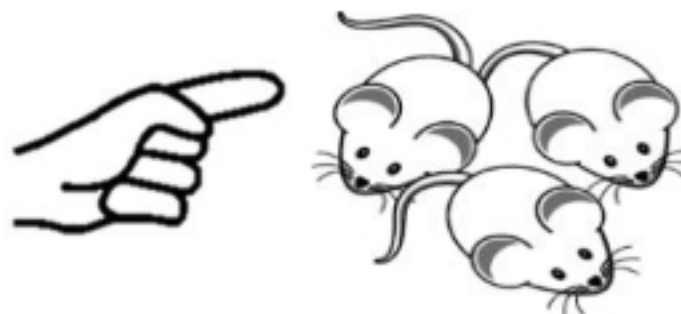

Q6. Grammar:

5

1. (She - They- I) is in the kitchen.
2. She (work - works- working) in a school.
3. They (go - goes - going) to school in the morning.
4. I go to school (in - on - at) morning.
5. (Which - Where - What) is Hashim ? He is in the bedroom.

Good Luck

التاريخ: / / ١٤٤٤ هـ

الصف: الخامس الابتدائي

المادة: اللغة الإنجليزية

اختبار اللغة الإنجليزية نهائي - الدور الأول - للصف الخامس - الفصل الدراسي الثالث ١٤٤٤ هـ

اسم الطالب: الفصل:

I- General Questions:

A- Answer the following questions correctly:

6

1- What time is it?



A - It's seven o'clock.

B - It's five o'clock.

2- Do you watch TV in the evening?

A - Yes, I do.

B - Yes, I do.

B- Match the questions in column (A) with the correct answers in column (B):

A	B
1- How many days in the week?	() I get up at 6 o'clock.
2- Can I use your pen?	() He's a teacher.
3- What does he work?	() They are 7 days.
4- What time do you get up?	() Sure. Here you go.

II- Controlled Writing:

A- Complete the sentences with the correct word:

1- Ostriches can run but they can't

2- It's and very hot in

summer

sunny

fly

5

B- Rearrange the words to form a sentence:

1- play / I / friends / . / my / with

2- is / a / This / . / watch

III- Reading Short Sentence:

4

A- Read the sentences and match them with the correct pictures:

1- They are wallets. 2- It's a sheep. 3- It's snowy and cold. 4- They're cooks.



IV- Grammar:

5

A) Choose the correct word:

1- They (is - are) pencils.

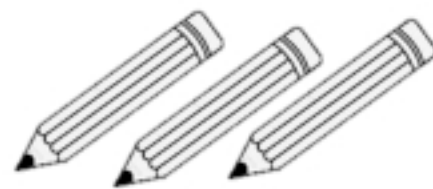

2- What (do - does) she do?

3- (That - These) is my eraser.



4- What are (this - these)?

5- The mouse is (under - on) the chair.



V- Vocabulary:

6

A) Write the correct number under each picture:

1- candy 2- watch 3- meat 4- kangaroo 5- scissors 6- firefighter



()



()



()



()



()



()

VI- Orthography:

4

A) Choose the correct letter:

ea - sp - sm - sw



1- __ an



2- h __ d



3- __ ort



4- __ ile

التاريخ: / / ١٤٤٤ هـ

الصف: الخامس الابتدائي

المادة: اللغة الإنجليزية

نموذج إجابة

المملكة العربية السعودية

وزارة التعليم

الإدارة العامة للتعليم بمنطقة

مكتب

مدرسة

اختبار اللغة الإنجليزية نهائي - الدور الأول - للصف الخامس - الفصل الدراسي الثالث ١٤٤٤ هـ

اسم الطالب: الفصل:

I- General Questions:

A- Answer the following questions correctly:

6

1- What time is it?



A - It's seven o'clock.

B - It's five o'clock.

2- Do you watch TV in the evening?

A - Yes, I do.

B - Yes, I do.

B- Match the questions in column (A) with the correct answers in column (B):

A	B
1- How many days in the week?	() I get up at 6 o'clock.
2- Can I use your pen?	(3) He's a teacher.
3- What does he work?	(1) They are 7 days.
4- What time do you get up?	(2) Sure. Here you go.

II- Controlled Writing:

A- Complete the sentences with the correct word:

1- Ostriches can run but they can't

2- It's and very hot in

B- Rearrange the words to form a sentence:

1- play / 1 / friends / 7 / my / with

2- is / a / This / . / watch

fly
Sunny
summer
This is a watch.

summer
sunny
fly

5

III- Reading Short Sentence:

4

A- Read the sentences and match them with the correct pictures:

- 1- They are wallets. 2- It's a sheep. 3- It's snowy and cold. 4- They're cooks.

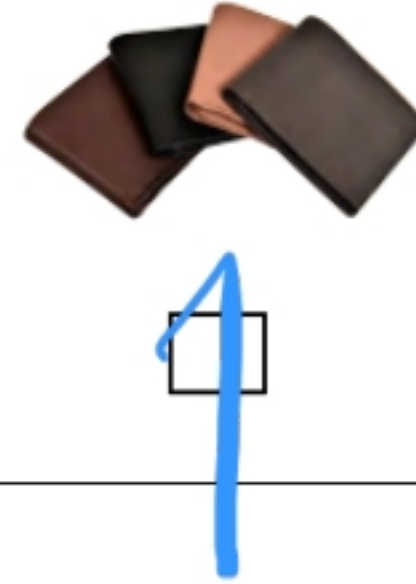
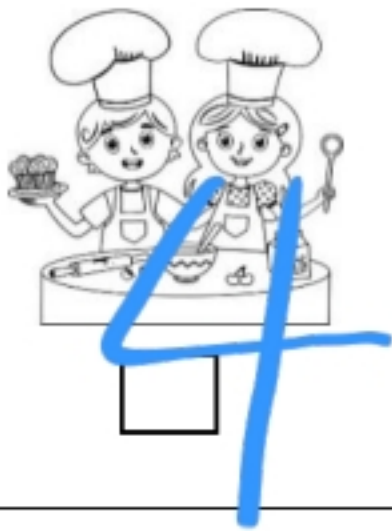

IV- Grammar:

5

A) Choose the correct word:

1- They (is - are) pencils.

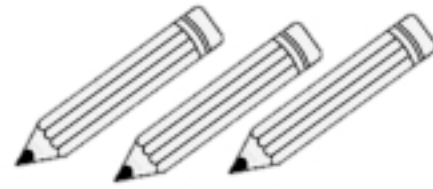

2- What (do - does) she do?

3- (That - These) is my eraser.



4- What are (this - these)?

5- The mouse is (under - on) the chair.



V- Vocabulary:

6

A) Write the correct number under each picture:

- 1- candy 2- watch 3- meat 4- kangaroo 5- scissors 6- firefighter

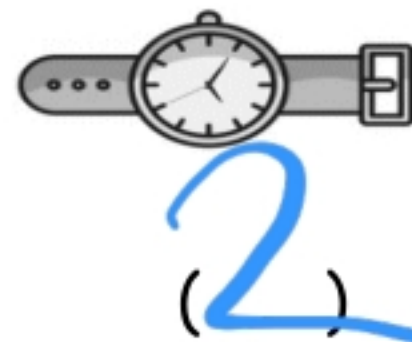

VI- Orthography:

4

A) Choose the correct letter:

ea - sp - sm - sw



اختبار مادة اللغة الانجليزية للصف الخامس الفصل الدراسي الثالث الدور

30

الاسم :

Q1. General Questions :

3

A)- Match:

1-What is the weather like?



It's 7:00 o'clock. please

2- Would you like to come in?

Yes, please.

3- What time is it?



It's rainy.

Q2. Controlled Writing :

5

A)- Complete with words from the box:

m / ee / ea / o / h

1- gr _ _ n.

2- s_all .

3- h_ _ d

4- ro_m

5- fis_

Q3. Complete numbers _:

7

A- 35 ____ 37 ____ 39 ____ 41 ____ 43

B- 50 ____ 70 ____ 80 ____

Q4. Grammar:

5

A)- Complete :

{ behind / on/ next to }

1- The elephant is..... the board .

2- The mouse isthe chair.

3- The cat isthe box.



B)- Choose the correct answer :

1 - are wallets.	This	These
2- These books.	is	are

Q5. Vocabulary:

6

C)- Read and write the suitable word :

bedroom / door / watch / sunny / scissors / doctor



..... / / / /

Q6. Writing :

A)- Copy 4 times :

I am playing football and tennis.

4

Four sets of horizontal lines for handwriting practice, each set consisting of a top line, a middle line, and a bottom line.

انتهت الأسئلة

Good Luck

اختبار مادة اللغة الانجليزية للصف الخامس الفصل الدراسي الثالث الدور

30

الاسم : نموذج الإجابة

Q1. General Questions :

3

A)- Match:

1-What is the weather like?



3

It's 7:00 o'clock. please

2- Would you like to come in?

2

Yes, please.

3- What time is it?



1

It's rainy.

Q2. Controlled Writing :

5

A)- Complete with words from the box:

m / ee / ea / o / h

1- gr_ _ n_

ee

2- s_ all_

m

3- h_ _ d

ea

4- ro_ n_

o

5- fis_ h

Q3. Complete numbers :

7

A- 35 36 37 38 39 40 41 42 43

B- 50 60 70 80 90

Q4. Grammar:

5

A)- Complete :

3 2 1
{ behind / on/ next to }

- 1- The elephant is..... the board .
- 2- The mouse isthe chair.
- 3- The cat isthe box.



B)- Choose the correct answer :

1 - are wallets.	This	These
2- These books.	is	are

Q5. Vocabulary:

6

C)- Read and write the suitable word :

bedroom / door / watch / sunny / scissors / doctor



..... / / / /

Q6. Writing :

A)- Copy 4 times :

I am playing football and tennis.

4

Four sets of horizontal lines for handwriting practice.

انتهت الأسئلة

Good Luck

اسم الطالب/هـ		المملكة العربية السعودية
رقم الجلوس :		وزارة التعليم
المادة : انجليزي		إدارة التعليم بمنطقة
الزمن : ساعة ونصف		مكتب التعليم
الصف : الخامس فصل ()		مدرسة :
الدرجة رقما :	التوقيع :	اسم المصحح / هـ :
الدرجة كتابة :	التوقيع :	اسم المراجع / هـ :
اختبار نهاية الفصل الدراسي الثالث للعام الدراسي 1443- لغة انجليزية — للصف الخامس ابتدائي		

General questions:

1 – Answer the following questions :

1 - What time do you eat your lunch ?

A . I eat my lunch at 2 : 00 . B . It starts at 7:00.

2 - Can kangaroos fly?

A. Yes, they can. B. No, they can't.

3 - Do you watch TV in the evening?

A . Yes, I am . B. Yes, I do .

4 - Can I use your pen?





A. No, thanks. B. Sure. Here you go.

5 - Would you like to come to my house?

A . Yes, please. B . I like ice cream.

Reading short sentences:

2 – Read and put ✓ or ✗ :

1. It is rainy and wet.		✓	✗
2. He is a teacher.		✓	✗
3. The boy is in the kitchen.		✓	✗
4. The ball is under the table		✓	✗

Controlled writing:

2 – Do as shown between brackets :

1. This is the living (Choose)	room	kitchen	boy
2. summer , _____ , autumn , spring . (Choose)	Sunday	winter	Monday
3. are - What - ? - these (Rearrange)		
5.at - I - get - 6 - up - o'clock. (Rearrange)		

Grammar:





4 – Read and choose the correct answer:

1 - What this ?	am	are	is
2- They are	a wallet	wallets	book
3- the boy?	Where're	where's	who
4- he work in the office?	Do	Does	Go
5- He is = _____	She's	He's	It's

Vocabulary:





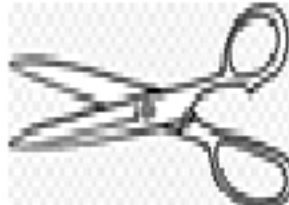

snail - present - astronaut - Scissors - candy - ostrich

5 – Write the correct word under each picture:

					
-----	-----	-----	-----	-----	-----

Orthography (Spelling):

7 – Choose the correct letter: (ee - sm - ou - sp - o - ee)

					
Sh__p	m__se	__ile	__eater	__ider	_x

انتهت الاسئلة

وفقكم الله

GOOD LUCK

لاتفسدوا ما آتاكم الله من فضله ولا تأكلوا أموالكم بالباطل ولا تأكلوا أموالكم بالباطل ولا تأكلوا أموالكم بالباطل
وني من صالح دعائكم

وَفَعَلِ اللهُ

T. Mohamad Zaid Al Asmari

نموذج إجابة

اسم الطالب/هـ	المملكة العربية السعودية
رقم الجلوس :	وزارة التعليم
المادة : انجليزي	إدارة التعليم بمنطقة
الزمن : ساعة ونصف	مكتب التعليم
الصف : الخامس فصل ()	مدرسة :
الدرجة رقما :	اسم المصحح / هـ :
الدرجة كتابة :	اسم المراجع / هـ :

نموذج إجابة اختبار نهاية الفصل الدراسي الثالث للعام الدراسي 1443 - لغة انجليزية - للصف الخامس ابتدائي

General questions:

1 - Answer the following questions :

5

1 - What time do you eat your lunch ?

A . I eat my lunch at 2 : 00 . B . It starts at 7:00.

1

2 - Can kangaroos fly?

A . Yes, they can . B . No, they can't.

1

3 - Do you watch TV in the evening ??

A . Yes, I am . B . Yes, I do .

1

4 - Can I use your pen ?

A . No, thanks . B . Sure. Here you go.

1

5 - Would you like to come to my house ?

A . Yes, please . B . I like ice cream.

1

Reading short sentences:

2 - Read and put ✓ or ✗ :

4

1. It is rainy and wet.

1



✓

✗

2. He is a teacher.

1



✓

✗

3. The boy is in the kitchen.

1



✓

✗

4. The ball is under the table

1



✓

✗

Controlled writing:

2 - Do as shown between brackets :

4

1. This is the living (Choose)

room

kitchen

boy

1

2. summer , _____ , autumn , spring . (Choose)

Sunday

winter

Monday

1

3. are - What - ? - these (Rearrange)

what are these?

1

4. at - I - get - 6 - up - o'clock. (Rearrange)

I get up at 6 o'clock.

1

Grammar:

4 – Read and choose the correct answer:

5







1 - What this ?	am	are	is	1
2- They are	a wallet	wallets	book	1
3- the boy?	Where're	where's	who	1
4- he work in the office?	Do	Does	Go	1
5- He is = _____	She's	He's	It's	1

Vocabulary:

snail - present - astronaut - Scissors - candy - ostrich

6

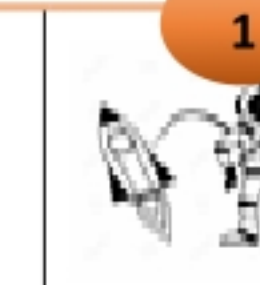





5 – Write the correct word under each picture:

					
candy	snail	present	ostrich	astronaut	Scissors

Orthography (Spelling):

6

7 – Choose the correct letter: (ee - sm - ou - sp - o - ee)

					
Sheep	mouse	smile	sweater	spider	ox
1	1	1	1	1	1

انتهت الاسئلة

وفقكم الله

GOOD LUCK

لا تنسوا
وني من صالح دعائكم

وَفَعَلِ اللهُ

T. Mohamad Zaid Al Asmari

المادة	لغة انجليزية	 <p>وزارة التعليم Ministry of Education</p> <p>اختبار الفصل الدراسي الثالث للعام الدراسي 1444 هـ</p> <p>https://t.me/abokhaledamer</p> 	<p>المملكة العربية السعودية وزارة التعليم الإدارة العامة للتعليم بن مدرسة مستقبل ن الابتدائية</p>
الصف	الخامس		
الزمن	ساعة ونصف		
الفصل	5/ ----		

اسم الطالب ربايعيا:

السؤال	1	2	3	4	5	6	المجموع
الدرجة							
الدرجة	6	5	4	5	6	4	30
المصحح							

I- General Questions:

Match the Following:

- | | |
|-----------------------------|---------------------------|
| 1. Can kangaroos fly? | a. Here you go. |
| 2. What does he do? | b. I get up at 6 o'clock. |
| 3. Can I use your pen? | c. O-X |
| 4. What time do you get up? | d. It's 2 o'clock. |
| 5. How do you spell ox? | e. No, they can't. |
| 6. What time is it? | f. He is a teacher. |

6

II- Controlled Writing:

Rearrange the following:

- is - Who - the - boy? -----
- are - They - wallets. -----
- works - He - the - at - airport. -----
- 42 - 41 - 44 - 43 - 45 -----
- Spring - Winter - Summer - Fall -----

5

III- Reading Short Sentence

Match the sentence with the pictures:



He's an astronaut.

They are watches.

It's sunny and hot.

He eats lunch at 2 o'clock.



4

IV- Grammar:

Choose the correct answer:

1. The mouse is _____ the chair. (in - on)
2. What is _____? (this - these)
3. These _____ pens. (is - are)
4. _____ are teeth. (These - Those)
5. _____ is a pilot. (She - He)



5



V- Vocabulary:

Write the correct word under each picture:

cook - kitchen - behind - house - scissors



6

Circle the odd word:

1. pen - pencil - glue - red - paper.
2. teacher - bedroom - architect - technician - pilot
3. bathroom - yard - bedroom - kitchen - spring.

VI- Spelling:

Choose the correct letter:



br _ _ d
(ea - ee)



_ _ rog
(h - f)



_ _ ider
(sp - sw)



clo _ _ dy
(o - u)

4

End of Questions (0557325813)

المادة	اللغة انجليزية	 <p>وزارة التعليم Ministry of Education</p> <p>اختبار الفصل الدراسي الثالث للعام الدراسي 1444 هـ</p> <p>https://t.me/abokhaledamer</p>	<p>المملكة العربية السعودية وزارة التعليم الإدارة العامة للتعليم بن مدرسة مستقبل ن الابتدائية</p>
الصف	الخامس		
الزمن	ساعة ونصف		
الفصل	5/ ----		

اسم الطالب ربايعيا:

السؤال	1	2	3	4	5	6	المجموع
الدرجة							
الدرجة	6	5	4	5	6	4	30
المصحح							

I- General Questions:

Match the Following:

- | | |
|-----------------------------|---------------------------|
| 1. Can kangaroos fly? | a. Here you go. |
| 2. What does he do? | b. I get up at 6 o'clock. |
| 3. Can I use your pen? | c. O-X |
| 4. What time do you get up? | d. It's 2 o'clock. |
| 5. How do you spell ox? | e. No, they can't. |
| 6. What time is it? | f. He is a teacher. |

6

II- Controlled Writing:

Rearrange the following:

- is - Who - the - boy?
- are - They - wallets.
- works - He - the - at - airport.
- 42 - 41 - 44 - 43 - 45
- Spring - Winter - Summer - Fall

Who is the boy?

They are wallets.

He works at the airport?

41 - 42 - 43 - 44 - 45

Winter - spring - summer - fall

5

III- Reading Short Sentence

Match the sentence with the pictures:



He's an astronaut.

They are watches.

It's sunny and hot.

He eats lunch at 2 o'clock.



4

IV- Grammar:

Choose the correct answer:

1. The mouse is _____ the chair. (in - **on**)
2. What is _____? (**this** - these)
3. These _____ pens. (is - **are**)
4. _____ are teeth. (**These** - Those)
5. _____ is a pilot. (She - **He**)



5



V- Vocabulary:

Write the correct word under each picture:

cook - kitchen - behind - house - scissors

6



cook



scissors



kitchen

Circle the odd word:

1. pen - pencil - glue - **red** - paper.
2. teacher - **bedroom** - architect - technician - pilot
3. bathroom - yard - bedroom - kitchen - **spring**.

VI- Spelling:

Choose the correct letter:

4



br **ea** d

(**ea** - ee)



f rog

(h - **f**)



sp ider

(**sp** - sw)



clo **u** dy

(o - **u**)

End of Questions (0557325813)

اختبار مادة اللغة الانجليزية للصف الخامس الفصل الدراسي الثالث الدور

30

الاسم :

Q1. General Questions :

3

A)- Match:

1-What is the weather like?



It's 7:00 o'clock. please

2- Would you like to come in?

Yes, please.

3- What time is it?



It's rainy.

Q2. Controlled Writing :

5

A)- Complete with words from the box:

m / ee / ea / o / h

1- gr _ _ n.

2- s_all .

3- h_ _ d

4- ro_m

5- fis_

Q3. Complete numbers :

7

A- 35 ____ 37 ____ 39 ____ 41 ____ 43

B- 50 ____ 70 ____ 80 ____

Q4. Grammar:

5

A)- Complete :

{ behind / on/ next to }

1- The elephant is..... the board .

2- The mouse isthe chair.

3- The cat isthe box.



B)- Choose the correct answer :

1 - are wallets.	This	These
2- These books.	is	are

Q5. Vocabulary:

6

C)- Read and write the suitable word :

bedroom / door / watch / sunny / scissors / doctor



..... / / / /

Q6. Writing :

A)- Copy 4 times :

I am playing football and tennis.

4

Four sets of horizontal lines for handwriting practice, each set consisting of a top line, a middle line, and a bottom line.

انتهت الأسئلة

Good Luck